

MOC3010M, MOC3011M, MOC3012M, MOC3020M, MOC3021M, MOC3022M, MOC3023M 6-Pin DIP Random-Phase Optoisolators Triac Driver Output (250/400 Volt Peak)

Features

- Excellent I_{FT} stability—IR emitting diode has low degradation
- High isolation voltage—minimum 5300 VAC RMS
- Underwriters Laboratory (UL) recognized—File #E90700
- Peak blocking voltage
 - 250V-MOC301XM
 - 400V-MOC302XM
- VDE recognized (File #94766)
 - Ordering option V (e.g. MOC3023VM)

Applications

- Industrial controls
- Solenoid/valve controls
- Traffic lights
- Static AC power switch
- Vending machines
- Incandescent lamp dimmers
- Solid state relay
- Motor control
- Lamp ballasts

Description

The MOC301XM and MOC302XM series are optically isolated triac driver devices. These devices contain a GaAs infrared emitting diode and a light activated silicon bilateral switch, which functions like a triac. They are designed for interfacing between electronic controls and power triacs to control resistive and inductive loads for 115 VAC operations.

Schematic



Package Outlines



Absolute Maximum Ratings ($T_A = 25^\circ\text{C}$ unless otherwise noted)

Stresses exceeding the absolute maximum ratings may damage the device. The device may not function or be operable above the recommended operating conditions and stressing the parts to these levels is not recommended. In addition, extended exposure to stresses above the recommended operating conditions may affect device reliability. The absolute maximum ratings are stress ratings only.

| Symbol | Parameters | Device | Value | Units |
|---------------------|--|-------------------|----------------|----------------------|
| TOTAL DEVICE | | | | |
| T_{STG} | Storage Temperature | All | -40 to +150 | $^\circ\text{C}$ |
| T_{OPR} | Operating Temperature | All | -40 to +85 | $^\circ\text{C}$ |
| T_{SOL} | Lead Solder Temperature | All | 260 for 10 sec | $^\circ\text{C}$ |
| T_J | Junction Temperature Range | All | -40 to +100 | $^\circ\text{C}$ |
| V_{ISO} | Isolation Surge Voltage ⁽¹⁾ (peak AC voltage, 60Hz, 1 sec. duration) | All | 7500 | Vac(pk) |
| P_D | Total Device Power Dissipation @ 25 $^\circ\text{C}$ Ambient Derate above 25 $^\circ\text{C}$ | All | 330 | mW |
| | | | 4.4 | mW/ $^\circ\text{C}$ |
| EMITTER | | | | |
| I_F | Continuous Forward Current | All | 60 | mA |
| V_R | Reverse Voltage | All | 3 | V |
| P_D | Total Power Dissipation @ 25 $^\circ\text{C}$ Ambient Derate above 25 $^\circ\text{C}$ | All | 100 | mW |
| | | | 1.33 | mW/ $^\circ\text{C}$ |
| DETECTOR | | | | |
| V_{DRM} | Off-State Output Terminal Voltage | MOC3010M/1M/2M | 250 | V |
| | | MOC3020M/1M/2M/3M | 400 | |
| I_{TSM} | Peak Repetitive Surge Current (PW = 1ms, 120pps) | All | 1 | A |
| P_D | Total Power Dissipation @ 25 $^\circ\text{C}$ Ambient Derate above 25 $^\circ\text{C}$ | All | 300 | mW |
| | | | 4 | mW/ $^\circ\text{C}$ |

Note:

1. Isolation surge voltage, V_{ISO} , is an internal device dielectric breakdown rating. For this test, Pins 1 and 2 are common, and Pins 4, 5 and 6 are common.

Electrical Characteristics ($T_A = 25^\circ\text{C}$ Unless otherwise specified)**Individual Component Characteristics**

| Symbol | Parameters | Test Conditions | Device | Min. | Typ. | Max. | Units |
|------------------|---|---|--------|------|------|------|---------------|
| EMITTER | | | | | | | |
| V_F | Input Forward Voltage | $I_F = 10\text{mA}$ | All | | 1.15 | 1.5 | V |
| I_R | Reverse Leakage Current | $V_R = 3\text{V}, T_A = 25^\circ\text{C}$ | All | | 0.01 | 100 | μA |
| DETECTOR | | | | | | | |
| I_{DRM} | Peak Blocking Current, Either Direction | Rated $V_{\text{DRM}}, I_F = 0^{(2)}$ | All | | 10 | 100 | nA |
| V_{TM} | Peak On-State Voltage, Either Direction | $I_{\text{TM}} = 100\text{ mA peak}, I_F = 0$ | All | | 1.8 | 3 | V |

Transfer Characteristics

| Symbol | DC Characteristics | Test Conditions | Device | Min. | Typ. | Max. | Units |
|-----------------|-----------------------------------|-----------------------------|----------|------|------|------|---------------|
| I_{FT} | LED Trigger Current | Voltage = $3\text{V}^{(3)}$ | MOC3020M | | | 30 | mA |
| | | | MOC3010M | | | 15 | |
| | | | MOC3021M | | | | |
| | | | MOC3011M | | | 10 | |
| | | | MOC3022M | | | | |
| | | | MOC3012M | | | 5 | |
| | | | MOC3023M | | | | |
| I_{H} | Holding Current, Either Direction | | All | | 100 | | μA |

Notes:

- Test voltage must be applied within dv/dt rating.
- All devices are guaranteed to trigger at an I_F value less than or equal to max I_{FT} . Therefore, recommended operating I_F lies between max I_{FT} (30mA for MOC3020M, 15mA for MOC3010M and MOC3021M, 10mA for MOC3011M and MOC3022M, 5mA for MOC3012M and MOC3023M) and absolute max I_F (60mA).

Safety and Insulation Ratings

As per IEC 60747-5-2, this optocoupler is suitable for “safe electrical insulation” only within the safety limit data. Compliance with the safety ratings shall be ensured by means of protective circuits.

| Symbol | Parameter | Min. | Typ. | Max. | Unit |
|------------|---|--------|-----------|------|------------|
| | Installation Classifications per DIN VDE 0110/1.89 Table 1 | | | | |
| | For Rated Main Voltage < 150Vrms | | I-IV | | |
| | For Rated Main voltage < 300Vrms | | I-IV | | |
| | Climatic Classification | | 55/100/21 | | |
| | Pollution Degree (DIN VDE 0110/1.89) | | 2 | | |
| CTI | Comparative Tracking Index | 175 | | | |
| V_{PR} | Input to Output Test Voltage, Method b, $V_{IORM} \times 1.875 = V_{PR}$, 100% Production Test with $t_m = 1$ sec, Partial Discharge < 5pC | 1594 | | | V_{peak} |
| | Input to Output Test Voltage, Method a, $V_{IORM} \times 1.5 = V_{PR}$, Type and Sample Test with $t_m = 60$ sec, Partial Discharge < 5pC | 1275 | | | V_{peak} |
| V_{IORM} | Max. Working Insulation Voltage | 850 | | | V_{peak} |
| V_{IOTM} | Highest Allowable Over Voltage | 6000 | | | V_{peak} |
| | External Creepage | 7 | | | mm |
| | External Clearance | 7 | | | mm |
| | Insulation Thickness | 0.5 | | | mm |
| RIO | Insulation Resistance at T_s , $V_{IO} = 500V$ | 10^9 | | | Ω |

Typical Performance Curves

Figure 1. LED Forward Voltage vs. Forward Current



Figure 2. On-State Characteristics

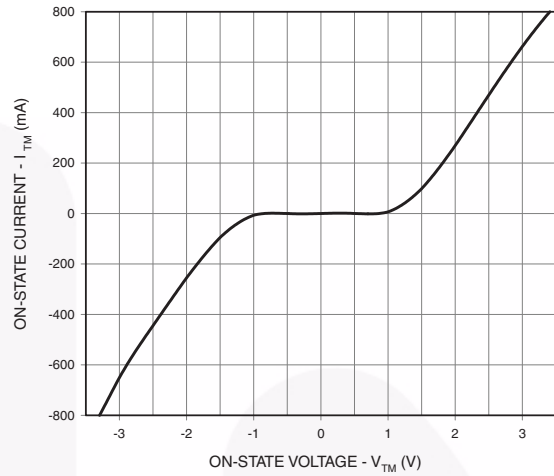

Figure 3. Trigger Current vs. Ambient Temperature



Figure 4. LED Current Required to Trigger vs. LED Pulse Width



Figure 5. dv/dt vs. Temperature

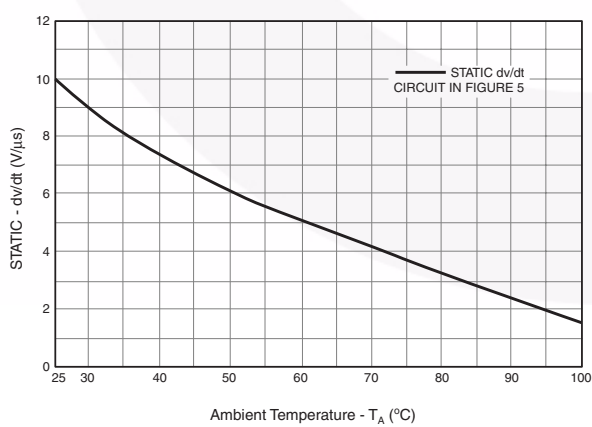
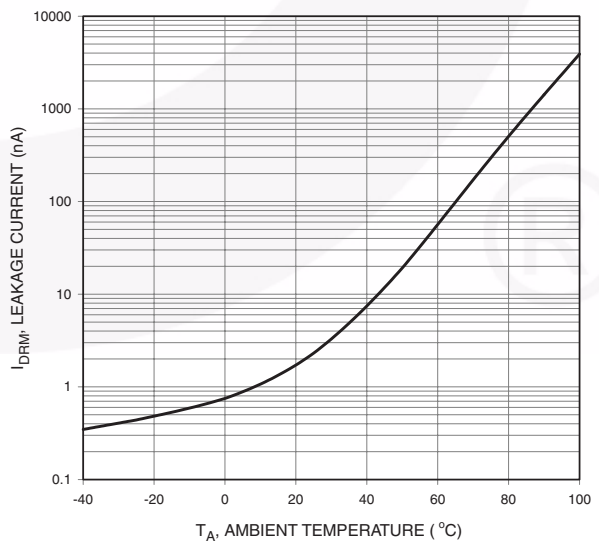
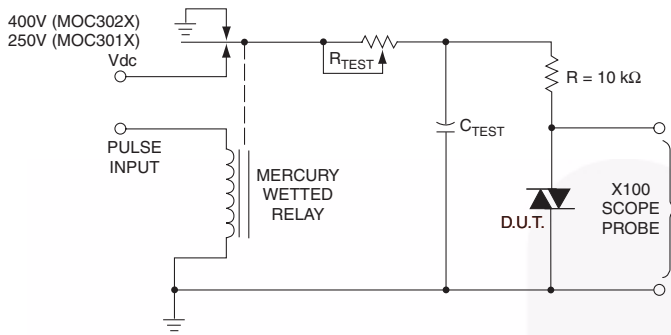

Figure 6. Leakage Current, I_{DRM} vs. Temperature





1. The mercury wetted relay provides a high speed repeated pulse to the D.U.T.
2. 100x scope probes are used, to allow high speeds and voltages.
3. The worst-case condition for static dv/dt is established by triggering the D.U.T. with a normal LED input current, then removing the current. The variable R_{TEST} allows the dv/dt to be gradually increased until the D.U.T. continues to trigger in response to the applied voltage pulse, even after the LED current has been removed. The dv/dt is then decreased until the D.U.T. stops triggering. τ_{RC} is measured at this point and recorded.

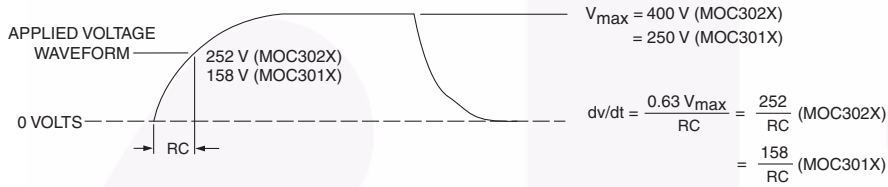

Figure 5. Static dv/dt Test Circuit

Note:

This optoisolator should not be used to drive a load directly. It is intended to be a trigger device only.

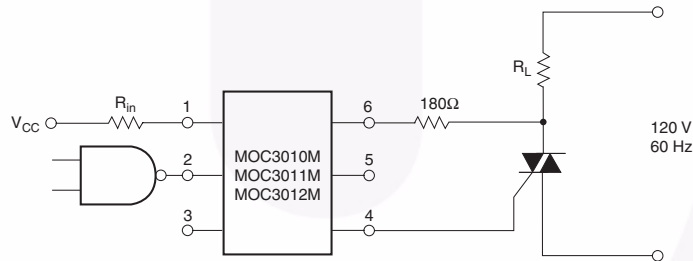

Figure 6. Resistive Load



Figure 7. Inductive Load with Sensitive Gate Triac ($I_{GT} = 15 \text{ mA}$)



Figure 8. Inductive Load with Sensitive Gate Triac ($I_{GT} \leq 15 \text{ mA}$)

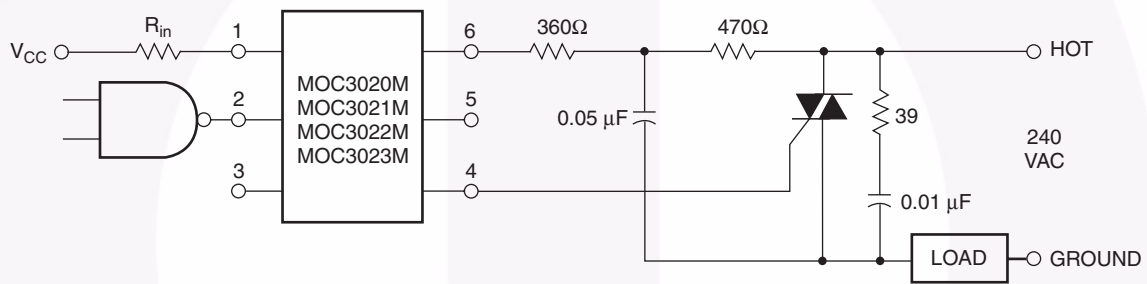

In this circuit the “hot” side of the line is switched and the load connected to the cold or ground side. The 39Ω resistor and 0.01μF capacitor are for snubbing of the triac, and the 470Ω resistor and 0.05μF capacitor are for snubbing the coupler. These components may or may not be necessary depending upon the particular and load used.

Figure 9. Typical Application Circuit

Package Dimensions

Through Hole



0.4" Lead Spacing

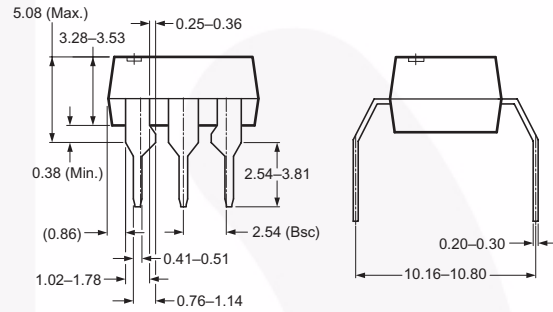
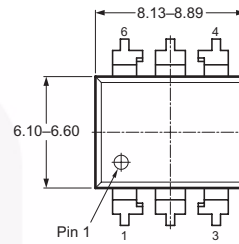

Surface Mount

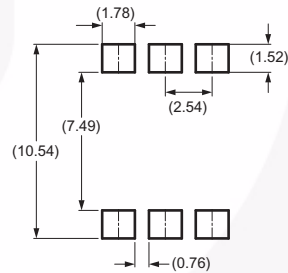

Recommended Pad Layout

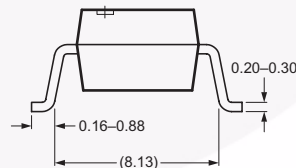
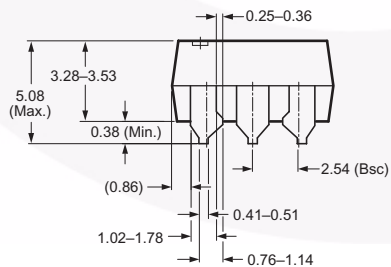

Note:
All dimensions in mm.

Ordering Information

| Option | Order Entry Identifier (Example) | Description |
|-----------|----------------------------------|--|
| No option | MOC3010M | Standard Through Hole Device |
| S | MOC3010SM | Surface Mount Lead Bend |
| SR2 | MOC3010SR2M | Surface Mount; Tape and Reel |
| T | MOC3010TM | 0.4" Lead Spacing |
| V | MOC3010VM | VDE 0884 |
| TV | MOC3010TVM | VDE 0884, 0.4" Lead Spacing |
| SV | MOC3010SVM | VDE 0884, Surface Mount |
| SR2V | MOC3010SR2VM | VDE 0884, Surface Mount, Tape and Reel |

Marking Information



| Definitions | |
|-------------|--|
| 1 | Fairchild logo |
| 2 | Device number |
| 3 | VDE mark (Note: Only appears on parts ordered with VDE option – See order entry table) |
| 4 | One digit year code, e.g., '3' |
| 5 | Two digit work week ranging from '01' to '53' |
| 6 | Assembly package code |

*Note – Parts that do not have the 'V' option (see definition 3 above) that are marked with date code '325' or earlier are marked in portrait format.

Carrier Tape Specification





Reflow Profile





TRADEMARKS

The following includes registered and unregistered trademarks and service marks, owned by Fairchild Semiconductor and/or its global subsidiaries, and is not intended to be an exhaustive list of all such trademarks.

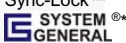
- | | | | |
|--|---|--|---|
| Auto-SPM™ | F-PFS™ | PowerTrench® | The Power Franchise® |
| Build it Now™ | FRFET® | PowerXS™ | the power franchise |
| CorePLUS™ | Global Power Resource™ | Programmable Active Droop™ | TinyBoost™ |
| CorePOWER™ | Green FPS™ | QFET® | TinyBuck™ |
| CROSSVOLT™ | Green FPS™ e-Series™ | QS™ | TinyLogic® |
| CTL™ | Gmax™ | Quiet Series™ | TINYOPTO™ |
| Current Transfer Logic™ | GTO™ | RapidConfigure™ | TinyPower™ |
| EcoSPARK® | IntelliMAX™ |  ™ | TinyPWM™ |
| EfficientMax™ | ISOPLANAR™ | Saving our world, 1mW/W/kW at a time™ | TinyWire™ |
| EZSWITCH™* | MegaBuck™ | SmartMax™ | TriFault Detect™ |
|  ™* | MICROCOUPLER™ | SMART START™ | TRUECURRENT™* |
|  ® | MicroFET™ | SPM® | μSerDes™ |
| Fairchild® | MicroPak™ | STEALTH™ |  ™ |
| Fairchild Semiconductor® | MillerDrive™ | SuperFET™ | UHC® |
| FACT Quiet Series™ | MotionMax™ | SuperSOT™-3 | Ultra FRFET™ |
| FACT® | Motion-SPM™ | SuperSOT™-6 | UniFET™ |
| FAST® | OPTOLOGIC® | SuperSOT™-8 | VCX™ |
| FastvCore™ | OPTOPLANAR® | SupreMOS™ | VisualMax™ |
| FETBench™ |  ™ | SyncFET™ | XS™ |
| FlashWriter®* | PDP SPM™ | Sync-Lock™ | |
| FPS™ | Power-SPM™ |  ™* | |

* Trademarks of System General Corporation, used under license by Fairchild Semiconductor.

DISCLAIMER

FAIRCHILD SEMICONDUCTOR RESERVES THE RIGHT TO MAKE CHANGES WITHOUT FURTHER NOTICE TO ANY PRODUCTS HEREIN TO IMPROVE RELIABILITY, FUNCTION, OR DESIGN. FAIRCHILD DOES NOT ASSUME ANY LIABILITY ARISING OUT OF THE APPLICATION OR USE OF ANY PRODUCT OR CIRCUIT DESCRIBED HEREIN; NEITHER DOES IT CONVEY ANY LICENSE UNDER ITS PATENT RIGHTS, NOR THE RIGHTS OF OTHERS. THESE SPECIFICATIONS DO NOT EXPAND THE TERMS OF FAIRCHILD'S WORLDWIDE TERMS AND CONDITIONS, SPECIFICALLY THE WARRANTY THEREIN, WHICH COVERS THESE PRODUCTS.

LIFE SUPPORT POLICY

FAIRCHILD'S PRODUCTS ARE NOT AUTHORIZED FOR USE AS CRITICAL COMPONENTS IN LIFE SUPPORT DEVICES OR SYSTEMS WITHOUT THE EXPRESS WRITTEN APPROVAL OF FAIRCHILD SEMICONDUCTOR CORPORATION.

As used herein:

- Life support devices or systems are devices or systems which, (a) are intended for surgical implant into the body or (b) support or sustain life, and (c) whose failure to perform when properly used in accordance with instructions for use provided in the labeling, can be reasonably expected to result in a significant injury of the user.
- A critical component in any component of a life support, device, or system whose failure to perform can be reasonably expected to cause the failure of the life support device or system, or to affect its safety or effectiveness.

ANTI-COUNTERFEITING POLICY

Fairchild Semiconductor Corporation's Anti-Counterfeiting Policy. Fairchild's Anti-Counterfeiting Policy is also stated on our external website, www.fairchildsemi.com, under Sales Support.

Counterfeiting of semiconductor parts is a growing problem in the industry. All manufacturers of semiconductor products are experiencing counterfeiting of their parts. Customers who inadvertently purchase counterfeit parts experience many problems such as loss of brand reputation, substandard performance, failed applications, and increased cost of production and manufacturing delays. Fairchild is taking strong measures to protect ourselves and our customers from the proliferation of counterfeit parts. Fairchild strongly encourages customers to purchase Fairchild parts either directly from Fairchild or from Authorized Fairchild Distributors who are listed by country on our web page cited above. Products customers buy either from Fairchild directly or from Authorized Fairchild Distributors are genuine parts, have full traceability, meet Fairchild's quality standards for handling and storage and provide access to Fairchild's full range of up-to-date technical and product information. Fairchild and our Authorized Distributors will stand behind all warranties and will appropriately address any warranty issues that may arise. Fairchild will not provide any warranty coverage or other assistance for parts bought from Unauthorized Sources. Fairchild is committed to combat this global problem and encourage our customers to do their part in stopping this practice by buying direct or from authorized distributors.

PRODUCT STATUS DEFINITIONS

Definition of Terms

| Datasheet Identification | Product Status | Definition |
|--------------------------|-----------------------|---|
| Advance Information | Formative / In Design | Datasheet contains the design specifications for product development. Specifications may change in any manner without notice. |
| Preliminary | First Production | Datasheet contains preliminary data; supplementary data will be published at a later date. Fairchild Semiconductor reserves the right to make changes at any time without notice to improve design. |
| No Identification Needed | Full Production | Datasheet contains final specifications. Fairchild Semiconductor reserves the right to make changes at any time without notice to improve the design. |
| Obsolete | Not In Production | Datasheet contains specifications on a product that is discontinued by Fairchild Semiconductor. The datasheet is for reference information only. |

Rev. I40